

Electronic DC Loads

REGENERATIVE LOAD ERI SERIES

Production Series B



- Energy recycling to the local power grid
- Low heat waste, silent
- Basic operating modes CC, CV, CR, CP
- Combined operating modes CC+CV, CR+CV, CP+CV, CV+CC, CR+CC, CP+CC
- Adjustable protections for current and under-voltage
- Optional MPP tracking
- Master-slave operation for parallel connection
- Dynamic load with synchronized DAQ
- Data storage directly to USB flash drive
- Functions for testing energy storage devices
- Internal resistance measurement
- Watchdog function in remote operation
- Electronic protection
- Galvanically isolated I/O port optional
- Bilingual help system (German/English)

ERI Series – Brief Profile

The electronic loads of the ERI series feed the absorbed energy back into the local supply network. This protects the environment and reduces electricity costs. A pleasant laboratory operation is given with this technology, quiet and cool.

The devices have an extensive range of data interfaces. In addition to Ethernet, USB and RS-232, a CAN interface is also built in as standard. GPIB can be optionally installed (ERI02).

Interfaces

- RS-232
- USB
- LAN
- GPIB
- CAN
- Analog
- Analog isolated

● Standard ○ Option — not available

Your contact:

Schulz-Electronic
Professional Power Supplies

Schulz-Electronic GmbH
Dr.-Rudolf-Eberle-Straße 2
D-76534 Baden-Baden
Fon + 49.7223.9636.0
Fax + 49.7223.9636.90
vertrieb@schulz-electronic.de
www.schulz-electronic.de

Operating Modes

The devices have the basic operating modes constant current, constant voltage, constant resistance and constant power (CC, CV, CR, CP mode). A protection value for undervoltage and overcurrent can be set in each operating mode. This allows the combined operating modes CC+CV, CR+CC+CV, CP+CC+CV, CV+CC to be realized.

Protection, Monitoring

- Current protection
- Power protection
- Overtemperature protection
- Overvoltage indication
- Reverse polarity indication
- Undervoltage protection
- Simple mains supply monitoring

Loading Capacity

The model range covers three power classes from 3,600 W to 10,800 W and input voltages of 120 V and 400 V.

Cooling

Instead of heating, the devices feed the absorbed energy back into the supply network. This alone reduces electricity costs, and the environment is heated only minimally. In many cases, this eliminates the need for air conditioning.

No powerful fans are required for regenerative loads, which makes the units pleasantly quiet compared to linear loads and thus perfect for laboratory operation.

Galvanically Isolated I/O Port (Option ERI06)

Analog signals
in realtime!

Optional galvanically isolated I/O port for:

- Analog load setting I and V
- Analog setting of I and V protections
- Load on-off
- Analog voltage monitor output
- Analog current monitor output
- Trigger input
- Trigger output
- Digital input
- Programmable control output

The galvanically isolated I/O port prevents ground loops and allows loading of bipolar voltages with two loads and common analog control.

Factory Calibration Certificate (FCC-ERlxx)

2 x for free

We supply a free Factory Calibration Certificate (FCC) with the devices. The calibration process is subject to supervision in accordance with DIN EN ISO 9001. This calibration certificate documents the traceability to national standards to illustrate the physical device in accordance with the International System of Units (SI). Within the 2-year warranty period, we will calibrate a second time free of charge if the respective device will have been registered:

<https://www.hoecherl-hackl.com/service/device-registration>

For use under laboratory conditions, H&H recommends a calibration interval of 2 years. This is an empirical value that can be used as a guide for the first period of use. Depending on the intended use, service life, relevance of the application and ambient conditions, the operator should adjust this interval accordingly.

Energy Recycling

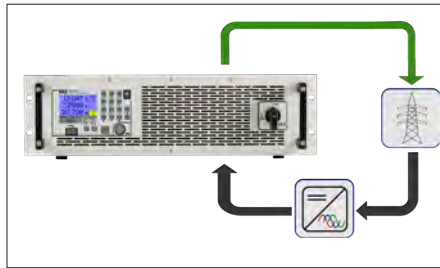

Energy recycling principle

The consumed energy is fed back to the mains supply.

The operation in the sense of a power generation into the public electricity grid is not provided with these energy recycling loads. The load must be connected to a low-voltage mains supply with a fixed installed and separately fused supply line. The ERI load has a simple and non-redundant monitoring of the power supply. If limit values are exceeded, it switches off the power stage unit. This monitoring does not replace any grid or system protection which must be installed if necessary for the protection of persons and the local grid.

Mechanics

The ERI load has a sturdy 19" rack design and can also be used as a table-top device. No additional mounting kits are needed for 19" rack installation.

Safety Covers

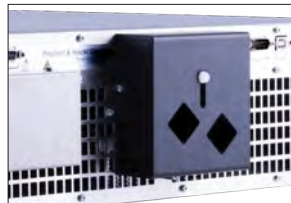

Safety cover ERI series

Covers are supplied as touch protection for all ERI series models.

Overcurrent and Undervoltage Protection

Adjustable overcurrent and undervoltage protection are permanently active. Both protections work in all operating modes.

Undervoltage protection operates in two different modes:

- regulating transition (e.g. CC-CV operation at battery discharge)
- switching transition (short dead time, e.g. when switching the input voltage)

Static Data Logging

In slow processes, the electronic load can store voltage and current directly to a USB flash drive in manual mode. Storage intervals are in the range of seconds.

Load Profiles (List Function)

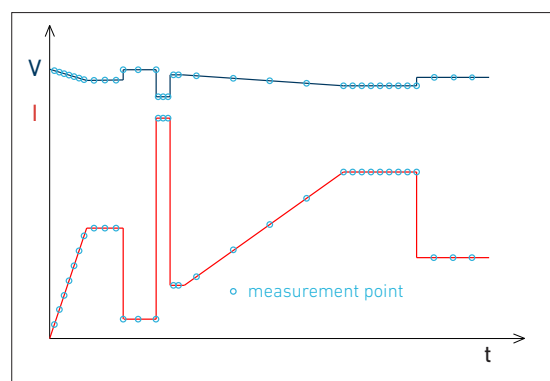

Waveform generated by List function with synchronized data acquisition of time, voltage, current

In all operating modes the PLI series loads can produce load profiles by List function. Up to 300 settings with variable dwell and ramp times are possible. Sample times can be defined for each section separately. The electronic load synchronously measures voltage and current and saves the data with timestamp.

Rectangular Function

New Rectangular		Local
Amplitude (A):	0.000 A	CC
Offset (O):	0.000 A	Med
t high:	0.0002 s	
t low:	0.0002 s	
f= 2.500kHz		Input
D= 50.00%		Off
OK		ESC

In addition to the list function, the user interface offers a convenient way of generating a rectangular load curve. When operating the load remotely via a data interface, a list of 2 setpoints is simply defined.

Data Acquisition (DAQ)

The electronic load can synchronously store data records of voltage and current with time stamp in a defined interval. Up to 8,000 data records are stored in a ring buffer. After the recording is finished, the data can be transferred to a USB flash drive.

Watchdog Function

In digital remote operation, the electronic load has got a watchdog function switching the load input off if the previously programmed watchdog delay expires without resetting the watchdog. The watchdog delay is set by SCPI command. Another command activates the watchdog. Then the control program must ensure that the command to reset the watchdog is sent periodically to the electronic load before the delay time expires.

Trigger Model

Several functions or settings can be triggered by a configurable trigger model:

- Start/stop LIST function
- Start/stop data acquisition
- Set triggered settings of all operating modes

Available trigger sources:

- Extern
- Bus
- Manual
- Voltage
- Current

Discharge Function, Energy Storage Test

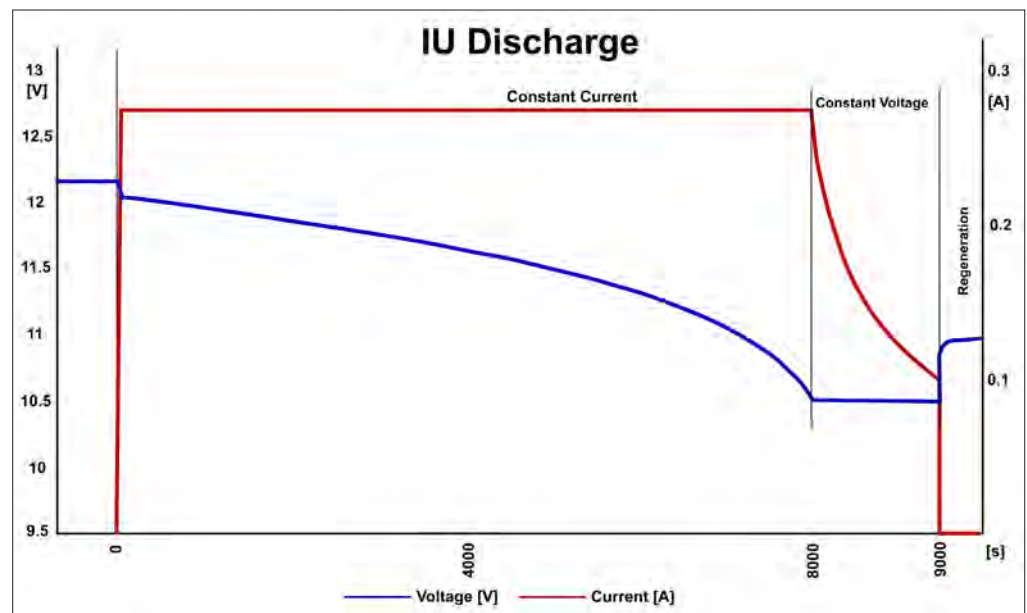

IUa discharge with follow-up time

The discharge function tests energy storage devices such as batteries, ultracaps, electrolytic capacitors and solar panels etc. by discharging them in CC, CP or CR mode. The discharge function can be combined with the list function so that pulsed discharge is possible.

IUa discharge (CC+CV discharge) is also possible: the test object is discharged with constant current up to a defined voltage. This voltage is then kept constant until a defined minimum current is reached.

Stop criteria are charge, energy, time, current, voltage.

During data logging, a follow-up time can be defined to observe the regeneration phase.

Changing Regulation Speed

Sometimes special DUTs or very long load cables require modification of the electronic load's regulation time constant to avoid oscillations and establish stable operation. Regulation speed slow - medium - fast are selectable at ERI loads. See model overview.

Internal Resistance Measurement

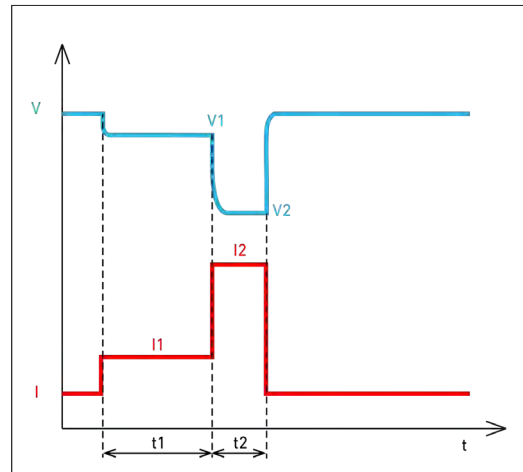

Ri calculation timing

The electronic load can measure the internal DC resistance of the connected DUT. The determination of the internal resistance R_i is based on the principle specified in various standards for batteries and accumulators, e.g. DIN EN 61951, DIN EN 61960. At intervals of a few seconds, the load measures the terminal voltage of the DUT (V_1 , V_2) at two defined load levels (I_1 , I_2) and calculates R_i from this. The load levels I_1 and I_2 as well as their durations are adjustable. In manual mode, the load can store the parameters and the result of the measurement on a connected USB stick at the touch of a button, so that a high throughput with many DUTs can be achieved.

MPP Tracking (Option ERI21)

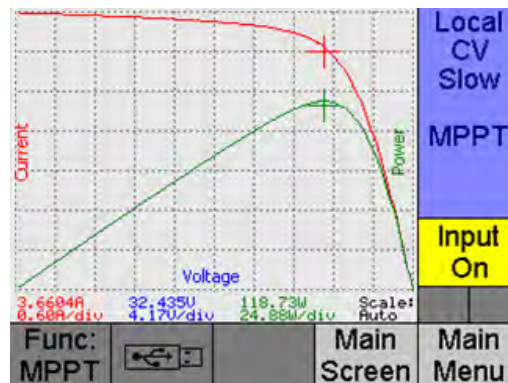

V/I and V/P characteristic at the user interface

The Maximum Power Point Tracking (MPPT) function consists of the two sub-functions Sweeping and Tracking, which alternate continuously in an adjustable interval.

If the measured open circuit voltage at startup is higher than the minimum voltage, the electronic load performs a sweep and then adjusts the global MPP found. The swept V/I curve is displayed together with the V/P curve in the function graph of the user interface. The previously found MPP is marked by a '+' in the diagram. The V/I characteristic can be read out via a data

interface. It is composed as follows:

<Volt_0>,<Curr_0>,<Volt_1>,<Curr_1>,...,<Volt_249>,<Curr_249>

Master-Slave Operation

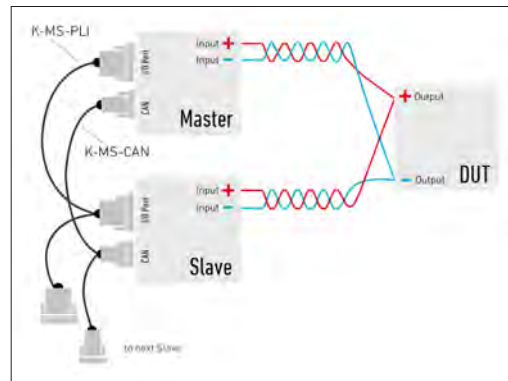

Master-Slave operation in system connection

Wiring:

A set of Master-Slave cable K-MS-ERI and K-MS-CAN cable in all Slave units (available from H&H or can be assembled by the user).

Limitations:

DAQ functions are not available in Master-Slave operation, functions for setting and reading device parameters are limited. The CAN interface is not available for data communication. When using the Master-Slave cables K-MS-ERI, the I/O port is also not accessible anymore. Nevertheless we offer a "SubD25 Doubler" as an accessory to be able to measure e.g. monitor signals.

Save Settings

In order to be able to quickly reconstruct frequently recurring test tasks, the settings active in the electronic load can be stored non-volatile so that they can be reloaded at a later time. 2 memory positions are available.

The load can optionally set the reset state when switching on, the last active settings at poweroff or memory positions 1 to 2.

Drivers



Current NI-certified LabVIEW drivers can be downloaded here:
www.ni.com/downloads/instrument-drivers/

Setting Menu



The ERI Tool is a graphical software tool to control the PLI series electronic loads. The user can choose different functions with the aid of the navigation bar.

The most important load settings are done in the main menu ("Settings"). Several graphical widgets inform the user about the measurements and the current device status. Further on, a data logging function can be activated in the main menu.

www.hoecherl-hackl.com

-> Download area

List Editor

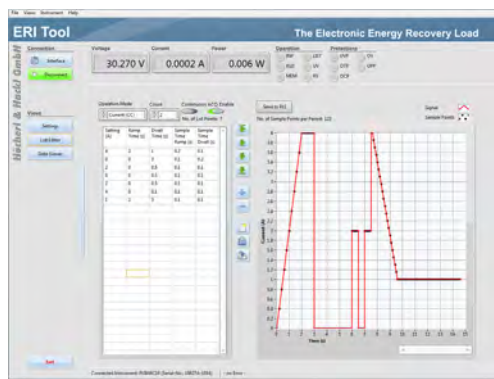

The list editor can be used to easily create dynamic load profiles for the electronic load. The user can enter the nominal setting values for current, voltage, power and resistance, the corresponding rise and fall times and the corresponding dwell times for each setting point of the list. Additionally, the List function allows the user to enable a synchronous data logging function for current and voltage measurements where the sampling times can be individually adjusted for each part of the load profile.

ERI power regeneration

Data Viewer



Measurement values of the internal DAQ memory can be exported from the electronic load and displayed as a diagram with the aid of the "Data Viewer". The measurement data can also be saved on a data storage as a .CSV file for further processing.

Model (Order number)	ERI3612	ERI3640
Maximum input voltage V _{max}	120 V	400 V
Minimum input voltage V _{min} ¹⁾	3 V	3 V
Maximum current I _{max}	110 A	45 A
Continuous power	3,600 W	3,600 W
Voltage setting	0 ... 120 V	0 ... 400 V
Current setting	0 ... 110 A	0 ... 45 A
Resistance setting	28 mΩ ... 11.73 Ω	67 mΩ ... 95.5 Ω
Power setting	0 ... 3,600 W	0 ... 3,600 W
Rise and fall time fast / medium / slow ²⁾	0,8 ms / 3 ms / 10 ms	1 ms / 3 ms / 10 ms
Input capacity ca.	350 μF	130 μF
Mains voltage ³⁾	1/N/PE AC 230 V 50 ... 60 Hz	1/N/PE AC 230 V 50 ... 60 Hz
Mains-side circuit breaker	C16	C16
Power consumption ⁴⁾	260 VA	260 VA
Maximum feed-in power	3,350 VA	3,350 VA
Efficiency ⁵⁾	90 %	90 %
Noise max. ⁶⁾	55 dB(A)	55 dB(A)
Load terminals ⁷⁾	FKS20/5-SM8 with safety cover	FKS20/5-SM8 with safety cover
Weight ca.	21 kg	21 kg
Housing / 3D model ⁸⁾	19", 3 U / ERI_M1	19", 3 U / ERI_M1

Model (Order number)	ERI7212	ERI7240
Maximum input voltage V _{max}	120 V	400 V
Minimum input voltage V _{min} ¹⁾	3 V	3 V
Maximum current I _{max}	220 A	90 A
Continuous power	7,200 W	7,200 W
Voltage setting	0 ... 120 V	0 ... 400 V
Current setting	0 ... 220 A	0 ... 90 A
Resistance setting	14 mΩ ... 5.86 Ω	34 mΩ ... 47.79 Ω
Power setting	0 ... 7,200 W	0 ... 7,200 W
Rise and fall time fast / medium / slow ²⁾	1.5 ms / 4.5 ms / 15 ms	1.5 ms / 4.5 ms / 15 ms
Input capacity ca.	700 μF	260 μF
Mains voltage ³⁾	2/N/PE AC 400/230 V 50 ... 60 Hz	2/N/PE AC 400/230 V 50 ... 60 Hz
Mains-side circuit breaker	C16	C16
Power consumption ⁴⁾	410 VA	410 VA
Maximum feed-in power	6,580 VA	6,580 VA
Efficiency ⁵⁾	90 %	90 %
Noise max. ⁶⁾	69 dB(A)	69 dB(A)
Load terminals ⁷⁾	FKS20/5-SM8 with safety cover	FKS20/5-SM8 with safety cover
Weight ca.	29 kg	29 kg
DHousing / 3D model ⁸⁾	19", 3 U / ERI_M1	19", 3 U / ERI_M1

1. Minimum input voltage for maximum static load current.
2. Rise and fall times are defined from 10 ... 90 % and 90 ... 10 % of maximum current at "fast" regulation speed (constant current mode, Tolerance ±20 %).
3. 1-phase at 3.6 kW, 2-phase at 7.2 kW, 3-phase at 10.8 kW, cross section mains wires: 2.5 ... 4 mm²
4. Power consumption in idle operation (without load current).
5. Maximum achievable efficiency.
6. Measured at the front in distance of 1 m.
7. Description of available terminals starting at page 109.
8. 1 U = 44.45 mm. Detailed dimensions by means of 3D models at www.hoerchl-hackl.com/downloads.

Model (Order number)	ERI10812	ERI10840
Maximum input voltage V _{max}	120 V	400 V
Minimum input voltage V _{min} ¹⁾	3 V	3 V
Maximum current I _{max}	330 A	135 A
Continuous power	10,800 W	10,800 W
Voltage setting	0 ... 120 V	0 ... 400 V
Current setting	0 ... 330 A	0 ... 135 A
Resistance setting	10 mΩ ... 3.91 Ω	23 mΩ ... 31.86 Ω
Power setting	0 ... 10,800 W	0 ... 10,800 W
Rise and fall time fast / medium / slow ²⁾	1.5 ms / 5 ms / 10 ms	1.5 ms / 5 ms / 10 ms
Input capacity ca.	1,050 μF	390 μF
Mains voltage ³⁾	3/N/PE AC 400/230 V 50 ... 60 Hz	3/N/PE AC 400/230 V 50 ... 60 Hz
Mains-side circuit breaker	C16	C16
Power consumption ⁴⁾	620 VA	620 VA
Maximum feed-in power	10,050 VA	10,050 VA
Efficiency ⁵⁾	90 %	90 %
Noise max. ⁶⁾	70 dB(A)	70 dB(A)
Load terminals ⁷⁾	FKS20/5-SM8 with safety cover	FKS20/5-SM8 with safety cover
Weight ca.	38 kg	38 kg
Housing / 3D model ⁸⁾	19", 3 U / ERI_M1	19", 3 U / ERI_M1

Options (Summary) and Accessories

Oder number	Article	Description
52-200-001-24	ERI02	GPIO interface extension
67-004-030-24	K-RS-SNM 9-9	RS-232 cable (null-modem cable) ERI series
53-100-007-24	ERI06	Galvanically isolated I/O port
63-000-005-25	PH2/7.62-ST16	Additional mating connector for sense terminal
63-000-003-00	SENSADAPT/PH2/ POK/60V	Sense adapter from Phoenix PH2 to 4 mm banana plugs, max. 60 V
63-000-004-00	SENSADAPT/PH2/ POK/1200V	Sense adapter from Phoenix PH2 to 4 mm banana plugs, max. 1200 V
67-036-020-24	K-MS-ERI	Master-Slave cable I/O port (2 m)
63-000-002-24	SubD25 Doubler	Adapter 1x Sub-D 25 male connector to 2x Sub-D 25 female connector for I/O port ERI series
65-002-000-24	FCC-ERlxx	Factory Calibration Certificate
		Load cables see starting at page 113

1. Minimum input voltage for maximum static load current.
2. Rise and fall times are defined from 10 ... 90 % and 90 ... 10 % of maximum current at "fast" regulation speed (constant current mode, Tolerance ±20 %).
3. 1-phase at 3.6 kW, 2-phase at 7.2 kW, 3-phase at 10.8 kW, cross section mains wires: 2.5 ... 4 mm²
4. Power consumption in idle operation (without load current).
5. Maximum achievable efficiency.
6. Measured at the front in distance of 1 m.
7. Description of available terminals starting at page 109.
8. 1 U = 44.45 mm. Detailed dimensions by means of 3D models at www.hoechertl-hackl.com/downloads.

Operating modes		
Basic operating modes	CC, CP, CR, CV	
Extended operating modes	CC+CV, CR+CC+CV, CP+CC+CV, CV+CC	
Accuracy of setting		
	of setting	of corresponding range
Voltage	±0.2 %	±0.05 %
Current	±0.2 %	±0.05 %
Resistance (at 5 % to 100 % of voltage range)	±1.4 %	±0.3 % of current range
Power (at V and I > 30 % of range) (at V or I < 30 % of range)	±0.35 %	±0.1 %
	±0.7 %	±0.25 %
Resolution	14 bits	
Accuracy of adjustable protections		
	of setting	of corresponding range
Overcurrent protection	±1.4 %	±0.3 %
Undervoltage protection	±1.4 %	±0.3 %
Resolution	12 bits	
Accuracy of measurement slow		
	of measured value (real value)	of corresponding range
Voltage	±0.03 %	±0.02 %
Current	±0.2 %	±0.05 %
Resistance	is calculated from current and voltage	
Power	is calculated from current and voltage	
Resolution	23 bits	
Sampling rate	250 ms, not triggerable	
Accuracy of display		
Number of decimal places	5	
Accuracy	Accuracy of measurement slow ±1 digit of the display value	
Accuracy of measurement fast		
	of measured value (real value)	of corresponding range
Voltage	±0.2 %	±0.1 %
Current	±0.2 %	±0.1 %
Resistance	is calculated from current and voltage	
Power	is calculated from current and voltage	
Resolution	16 bits	
Sampling rate	200 µs ... 1,000 s, resolution 200 µs	
Accuracy of trigger voltage and current measurement		
Trigger voltage	±1 % of voltage range	
Trigger current	±1 % of current range	
Sampling rate	200 µs	
Dynamic function (LIST)		
No. of load levels	max. 300, with corresponding ramp and dwell times	
Accuracy of load levels	see accuracy of setting	
	min.	max.
Dwell time	200 µs	1,000 s
Ramp time	0 s	1,000 s
Resolution	200 µs	
Accuracy of setting times	±0.02 %	
Sampling times	see accuracy of measurement fast	
Delay at triggered start	max. 300 µs	

Data acquisition		
to external USB flash drive		
Sampling rate	0.5 ... 30.0 s, resolution 0.1 s	
Measurement data	timestamp, voltage, current	
No. of measurement points	limited by flash drive memory capacity	
File format	.csv	
to internal memory		
Sampling rate	200 µs ... 1,000 s, resolution 200 µs, synchronized with dynamic function	
Measurement data	timestamp, voltage, current	
No. of measurement points	max. 40,000	
Settings memory		
No. of user settings	9, selectable (incl. programmed list) 1 for last device settings at power-off or power failure	
I/O port (option ERI06): accuracy of analog control 0 ... 10 V		
	of setting	of corresponding range
Voltage	±0.2 %	±0.1 %
Current	±0.2 %	±0.1 %
Overcurrent protection	±1 %	±0.4 %
Undervoltage protection	±1 %	±0.4 %
	Input resistance of analog inputs >10 kΩ	
I/O port (option ERI06): accuracy of analog monitor outputs 0 ... 10 V		
	of analog signal of actual value	offset voltage
Voltage	±0.2 %	±15 mV
Current	±0.2 %	±15 mV
	Permissible load > 2 kΩ	
I/O port (option ERI06): permissible voltages		
	isolated I/O port (Option ERI06)	
Vin-io (GND - neg. load input)	max. 625 V ¹⁾	
VioPE (GND - PE)	max. 125 V ¹⁾	
I/O-Port (option ERI06): outputs and inputs		
Outputs	activation state input (on/off, low active) overload status (OV, OCP, OPP, OTP, low active) trigger output (low active) programmable logic output (by SCPI command)	
Output level	selectable, 3.3 V, 5 V, 12 V, or externally programmable up to 30 V	
Inputs	activation state input (on/off, low active) mode selection trigger input (high active) readable logic input (by SCPI command) control input (activates the analog signals, low active) remote shut-down (low active)	
Input level	3 ... 30 V	

The specified accuracies refer to an ambient temperature of 23 ±5 °C. The specified accuracies are valid when the unit is connected to undisturbed voltages (ripple and noise < 0.1 %). At voltages with higher disturbance values the accuracy can change for the worse.

¹⁾ positive/negative DC voltage or RMS value of a sinusoidal AC voltage

Technical Data (continued)

Input	
Reverse polarity	diode function at reverse polarity up to nominal current
Input capacity	see model overview
Parallel operation	up to 5 devices in Master-Slave operation
Max. input voltage V _{max}	see model overview
Min. input voltage V _{min} for max. current	see model overview
Input: permissible voltages	
	isolated I/O port (option ERI06)
Vin-PE (neg. load input - PE)	max. 500 V ¹⁾
Vin+PE (pos. load input - PE)	max. 800 V ¹⁾
Power	
Continuous power	see model overview (at Ta = 21 °C)
Derating	-1,6 %/°C for Ta > 21 °C
Efficiency	see model overview
Protection and monitoring	
Protective devices	overcurrent overpower overtemperature
Monitoring signals	overvoltage indication undervoltage indication (if the input voltage is too low for the set current) reverse voltage indication
Terminals	
Load input	see model overview
Sense	PH2/7.62-BU16, see starting at page 109
Operating conditions	
Operating temperature	5 ... 40 °C
Stock temperature	-25 ... 65 °C
Operating height max.	2.000 m above sea level
Pollution degree	2
Overvoltage category of mains	II
Max. humidity	80 % at 31 °C, linear decreasing to 50 % at 40 °C
Min. distance rear panel - wall or other objects	70 cm
Cooling	temperature-controlled air cooling

Noise	see model overview
Mains	see model overview
Mains voltage tolerance	±10 %
Cross section of mains wires	2.5 ... 4 mm ² depending on design of the local low-voltage network and the length of the mains cable
Mains-side circuit breaker	see model overview
Power consumption in idle mode	see model overview
Maximum feed-in power	see model overview

Housing

Dimensions	see model overview
Weight	see model overview
Color	
Front	RAL7035 (light grey)
Rear	Stainless steel
Top, side panels	RAL7037 (dusty grey)

Safety and EMC

Protection class	1
Protection	IP20
Measuring category	0 (CAT I according to EN 61010:2004)
Electrical safety	DIN EN 61010-1 DIN EN 61010-2-030
EMC	DIN EN 61326-1 DIN EN 55011 DIN EN 61000-3-2 DIN EN 61000-3-3

Standard interfaces

Data interfaces	RS-232, USB, LAN, CAN
I/O port	-

Available options

Data interface ERI02	GPIB Interface
Hardware extension ERI06	Galvanically isolated I/O port

Kalibrierung, Gewährleistung

FCC-ER1xx	Factory Calibration Certificate, twice for free after registration
Warranty	2 years



¹⁾ positive/negative DC voltage or RMS value of a sinusoidal AC voltage